

INOVA®



MADE IN USA



TACTICAL/POLICE LED FLASHLIGHTS

Total professional quality with a visible difference

INOVA **TACTICAL/POLICE** LED FLASHLIGHTS

Total professional quality with a visible difference

The first full arsenal of tactical/police LED flashlights, the INOVA T-Series signals the end of the incandescent flashlight blues for professionals everywhere.

See farther

T-Series flashlights project more light, farther than any other in their size class.

See longer

They provide long burn times with constant, non-dimming brightness over battery life.

Get extreme durability and reliability

T-Series flashlights are built to high engineering, material and manufacturing standards.

Benefit from smooth handling and control

Their compact bodies and tactical switch designs provide operational excellence.

Gain strategic advantage

These quality tools outperform competing flashlights in virtually every way.



All models feature:

The revolutionary TIROS™ lens—protected by aluminum body walls up to .25" thick

Aircraft aluminum body machined from solid bar stock (not extruded tubing) with military-grade, Type III anodized hard-coat and stainless steel head

Lifetime LED bulbs—virtually indestructible

Power regulation for constant, non-dimming brightness over battery life

Double AR-coated mineral glass optical window with Teflon® seal that counters environmental pressure

Aggressive knurling for positive grip

Shock-proof, crush-proof and water-resistant construction (T4 rechargeable is not water resistant)

Battery/batteries included

Critical mating surfaces held to $\pm .0005$ " tolerances

O-ring compression sealing throughout

Limited lifetime warranty



The T-Series puts strategic advantage into the hands of professionals for whom every thought, action and piece of equipment can be critical to the mission.

Police and military personnel around the world rely on INOVA flashlights to get the job done. Our new T-Series flashlights give them more light with less bulk. Their smaller, highly efficient lens and battery systems allow compact body sizes that handle, transport and store with ease.

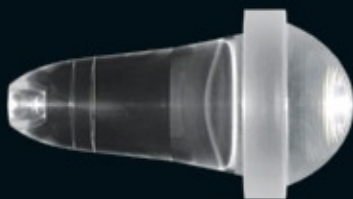

Up to +90% light efficiency

The patented TIROS (Total Internal Reflection Optical System) lens collects and fires more lumens per watt than any lens its size. Up to +90% of the light generated by the LED is delivered. It is the achievement of a joint two-year R&D effort with Optical Research Associates, the firm called upon by NASA and the US military to develop the world's most advanced optical systems.



Beam quality in the field

T-Series flashlights project a well-defined hot spot and balanced peripheral field over long distances. Users get excellent visibility of the target object plus illumination of the immediate surroundings.

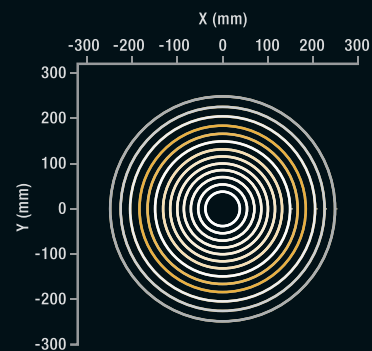

Measurable results

A digital imaging photometer analyzes TIROS beam concentration, intensity and uniformity in 2D and 3D views. The photometer provides an objective picture of the beam and provides insight into field performance.

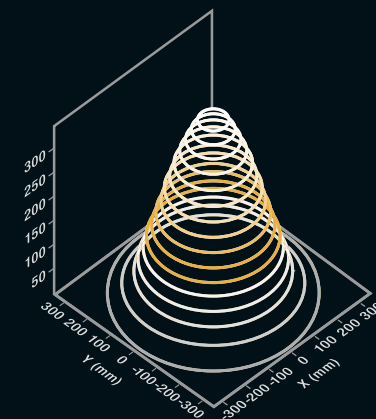

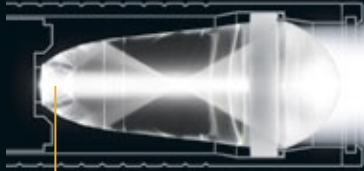

T1 and T2 models are equipped with the TIROS 22-mm optical system.

1.5 WATT LED FLASHLIGHT

T1™

T1 SPECIFICATIONS



35-LUMEN LED OUTPUT



1.5-HOUR BURN TIME

4.59" length x 0.98" diameter

1.5-watt lifetime LED

Up to 150' effective range

One 123A lithium battery included

End-switch control—press for momentary on, click for constant on/off

Patent-pending lock-out tail cap

ORDERING INFORMATION

MODEL T1-WB

UPC 671192-22005-9

Powerful and compact

The INOVA T1 provides palm-sized punch. It emits constant, non-dimming brightness for up to 1.5 hours. The T1 is the solution for professionals who want far-reaching brightness in a size that fits easily in a pocket. A lanyard opening expands transport options (also featured on the T2 and T3).

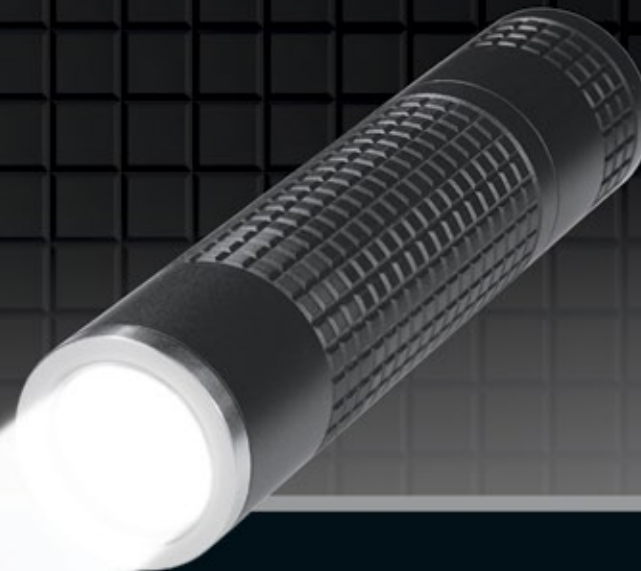

Tactical end-switch for the T1, T2, and T3

These models feature a patent-pending 3-way tactical switch. The end-position design enhances control of these flashlights, especially for overhand operation.

2 WATT LED FLASHLIGHT

T2™

The next step in compact power

The INOVA T2 offers all the features and functionality of the T1 in a larger, 2-battery version that delivers up to 5 hours of constant, non-dimming light output per battery set. It is the next step in efficient firepower, throwing light effectively up to 200'. At just under 6", the T2 offers professionals another strategic option that delivers maximum performance for its size.

T2 SPECIFICATIONS

 **40-LUMEN LED OUTPUT**

 **5-HOUR BURN TIME**

5.9" length x 0.98" diameter

2 watt lifetime LED

Up to 200' effective range

Two 123A lithium batteries included

End-switch control—press for momentary on, click for constant on/off

Patent-pending lock-out tail cap

ORDERING INFORMATION

MODEL T2-WB

UPC 671192-22020-2

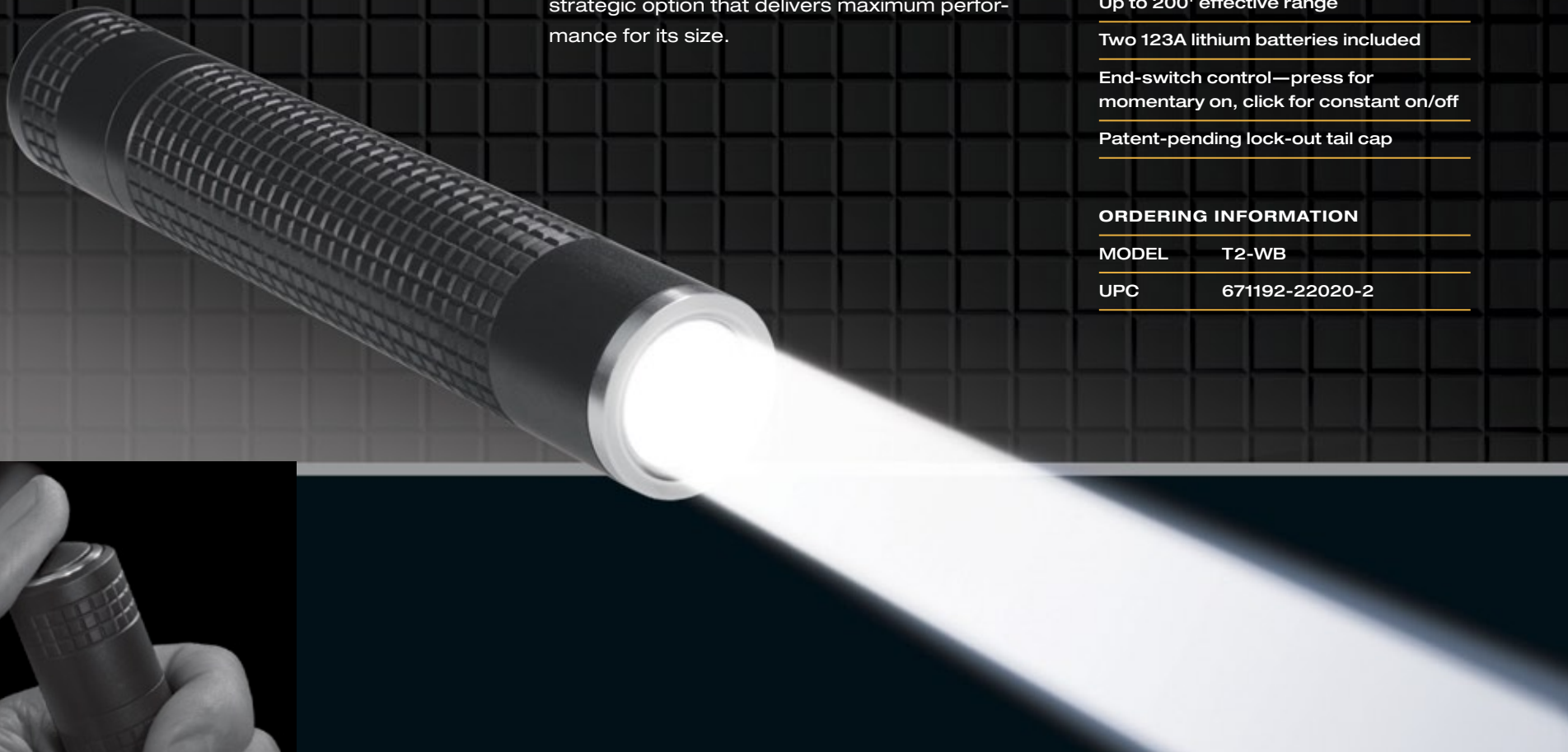

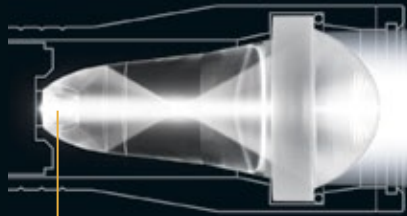

3.2 WATT LED FLASHLIGHT

T3™

T3, T4 and T5 models are equipped with the TIROS 29-mm optical system.

T3 SPECIFICATIONS

 **85-LUMEN LED OUTPUT**

 **2-HOUR BURN TIME**

6.25" length x 0.98" diameter

3.2 watt lifetime LED

Up to 250' effective range

Two 123A lithium batteries included

End-switch control—press for momentary on, click for constant on/off

Patent-pending lock-out tail cap

ORDERING INFORMATION

MODEL T3-WB

UPC 671192-22010-3

The balance of size and performance

The INOVA T3 provides a tactical balance of compact size and powerful light performance. By incorporating a flared head design in a body just 6.25" long, the T3 is capable of projecting light effectively up to 250'.

It delivers up to 2 hours of constant, non-dimming light output per battery set. Users get exceptional visibility from a rugged, durable instrument that is easy to handle, store and carry.



4 WATT RECHARGEABLE LED FLASHLIGHT

T4™

T4 SPECIFICATIONS

 100-LUMEN LED OUTPUT

 2-HOUR BURN TIME

 LITHIUM ION BATTERY INCL'D

8.0" length x 1.1" diameter

4 watt lifetime LED

Up to 300' effective range

Zero to full recharge in 3 hours

Includes charger cradle plus power supplies for AC and DC charging

Mid-body switch—located for optimal control; press for momentary on, click for constant on/off

ORDERING INFORMATION

MODEL T4-WB

UPC 671192-22000-4

The only dedicated rechargeable LED duty light

The INOVA T4 offers major benefits over competing rechargeables: it provides up to two times the burn time (up to 2 hours of constant, non-dimming output), recharges in about one-quarter of the time and projects light up to 300'.

The T4 can be recharged anytime without waiting for the battery to be fully discharged. Its battery can be recharged hundreds of times. With its performance and usability advantages, and lower battery replacement costs, the T4 is the best rechargeable LED flashlight professionals can buy.

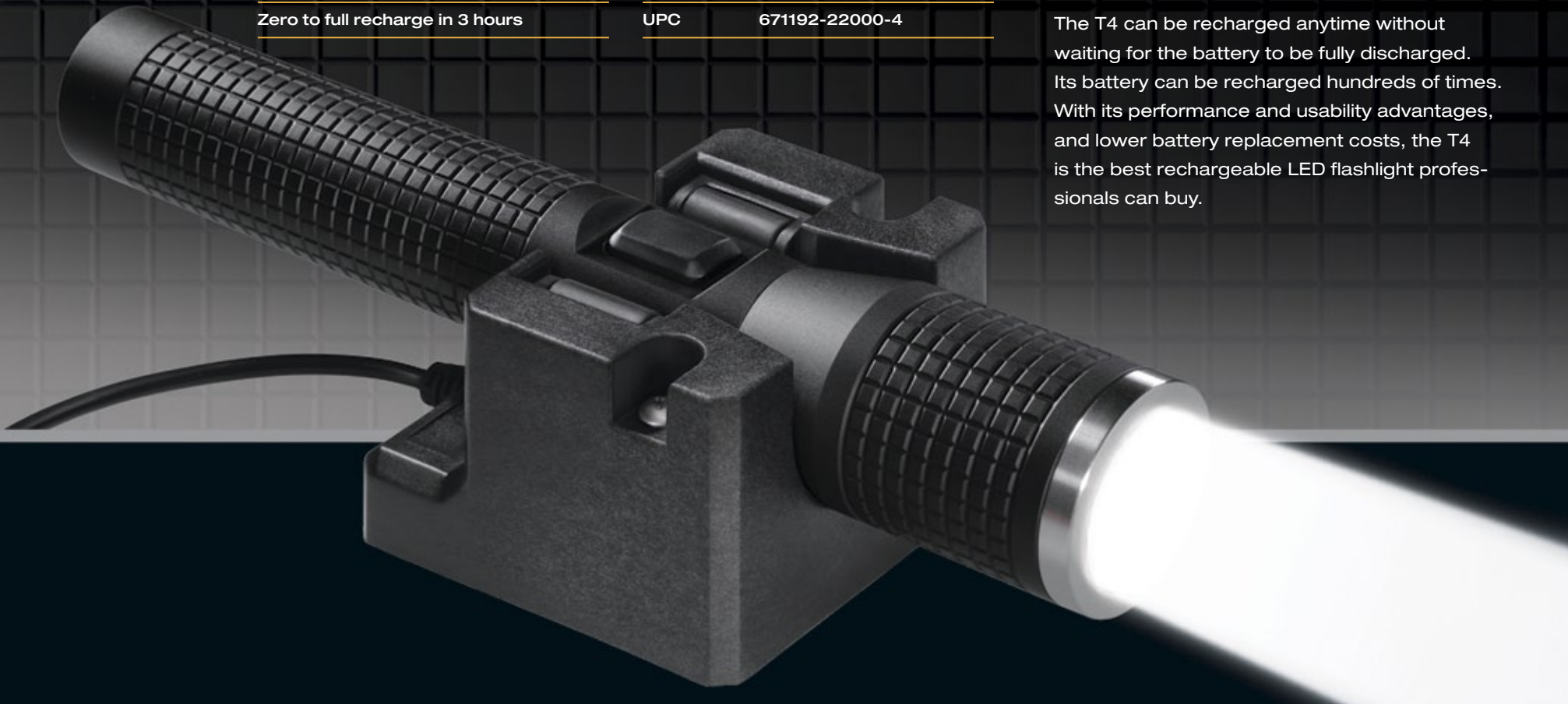

INCLUDED WITH THE INOVA T4



Lithium Ion—the best rechargeable battery

Unlike rechargeables that use multiple, heavy and inefficient NiCd batteries, the T4's high energy capacity comes from a single, efficient lithium ion battery.

- Recharges hundreds of times
- Supplies longer burn times
- Recharges in less time
- Can be recharged anytime—no waiting for full discharge
- Holds a significant charge even after months of storage

Charger—engineered from the ground up

Some manufacturers conveniently ignore the charger's importance to flashlight performance. We totally reinvented and engineered this critical piece of equipment, beginning with a compact, low-profile body for space efficiency.

- 1 Engineered spring-loaded rollers hold flashlight securely while offering ease of insertion/removal
- 2 Gold-plated charging contacts prevent reverse charging
- 3 Blue LED indicates recharge state
- 4 Nylon and glass fiber composite is strong and resilient



AC Power Supply

Quality AC Power Supply is smaller, lighter and more useful than competing products.

- 1 Optional international Adapter Kit—simply snap on/off



DC/Vehicle Power Supply

Sturdy DC/Vehicle Power Supply ensures secure connection to standard cigarette-lighter receptacles.

- 1 All INOVA T4 power-cable couplings are designed to stay connected in the most demanding environments.
- 2 Built-in fuse provides electronic protection

INOVA T4 ACCESSORIES AND REPLACEMENT PARTS



T4 Flashlight w/o Battery

MODEL	T4-L0
UPC	671192-23025-6



DC/Vehicle Power Supply

MODEL	T4-DC
UPC	671192-23005-8



T4 Charger Cradle

MODEL	T4-CR
UPC	671192-23015-7



10' Hardwire Cable

MODEL	T4-HK
UPC	671192-23020-1



AC Power Supply

MODEL	T4-AC
UPC	671192-23000-3



Lithium Ion Battery

MODEL	T4-B0
UPC	671192-23030-0



International Adapter Kit

MODEL	T4-IK
UPC	671192-23040-9



Lens Replacement Kit

MODEL	T4-LK
UPC	671192-23010-2

The Lens Replacement Kit may also be used for the INOVA T5 LED Flashlight

T5™

4 WATT LED FLASHLIGHT

T5 SPECIFICATIONS

 100-LUMEN LED OUTPUT

 3-HOUR BURN TIME

8.75" length x 1.1" diameter

4 watt lifetime LED

Up to 300' effective range

Three 123A lithium batteries included

Mid-body switch — located for optimal control; press for momentary on, click for constant on/off

ORDERING INFORMATION

MODEL T5-WB

UPC 671192-22015-8

Maximum brightness duty light

The INOVA T5 is nearly identical to the T4 in body construction, size and brightness but with single-use batteries. The T5 converts its 4-watt LED source into a beam that is effective up to 300' — visibly illuminating objects at football-field distances. It delivers up to 3 hours of constant, non-dimming light output per battery set. The INOVA T5 comes in a body that keeps handling responsive and transport easy.



Tactical mid-body switch for the T4 and T5

The 3-way mid-body switch of the T4 and T5 enables responsive activation and balanced handling.





INOVA®

TACTICAL/POLICE LED FLASHLIGHTS

Best-in-class light delivery—rugged, compact, reliable operation

EMISSIVE ENERGY® CORP.

135 Circuit Drive
N. Kingstown, RI 02852

tel 401 294.2030
fax 401 294.2050

www.inovalight.com

© 2005. INOVA, EMISSIVE ENERGY and BRILLIANT EQUIPMENT FOR LIFE are registered trademarks of EMISSIVE ENERGY CORP. T1, T2, T3, T4, T5 and TIROS are trademarks of EMISSIVE ENERGY CORP. Teflon® is a registered trademark of Dupont.

Manufactured under one or more United States or international patent numbers, US Patents: 6,709,129; 6,819,505; D495,078; D473,961. US Published Applications: 2004/0190285; 2004/0150990; 2004/0114393; 2004/0109310; 2003/0198042; 2003/0147239; 2003/0107885.

Other US and international utility and design patents are pending.

Made in USA with US and imported components. The distinctive shapes, styles, packaging, configurations and overall appearances of all INOVA flashlights and lighting products are trademarks of EMISSIVE ENERGY CORP. The unique bulb configurations, body and barrel shapes inherently identify them as members of the quality family of INOVA brand products. **LED lumen output may vary between flashlights.**